

Morse taper ejecting drifts according to DIN 317, hardened and black oxide special steel

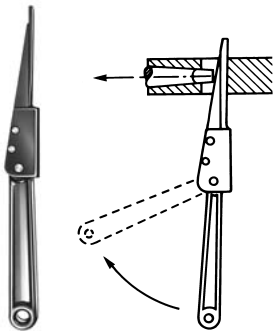

Model No.	Morse taper	Lenght mm	Packaging style	Weight g
DR0	0	90	Bulk	14
DR12	1-2	140		70
DR23	2-3	148		80
DR34	3-4	190		150
DR45	4-5	225		310
DR56	5-6	265		650



Automatic Morse taper ejecting drifts

Model No.	Morse taper	Lenght mm	Packaging style	Weight g
DRA123	1-2-3	320	Bulk	320
DRA456	4-5-6	380		580

Nail attachment with SDS adaptor to be fitted in a percussion power tool. A magnetic disc on front side provide nail catching for a quick and easy riveting.



Model No.	A mm	B mm	C mm	D mm	E Max size of nail head mm	Packaging style	Weight g
NASDS	23	29	78	13	10	Individual box	100
NASDSB						Blister card	

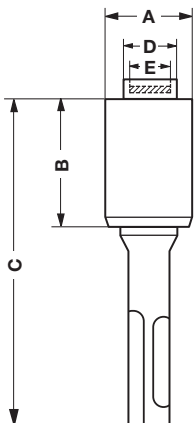

Reducing sleeves according to DIN 2185, hardened and tempered, precision ground internally and externally



Model No.	Morse taper		A mm	B mm	C mm	D mm	E mm	Packaging style	Weight g
	inside	outside							
B01	0	- 1	80	19	12.065	9.045	13.0	Individual box	30
B12	1	- 2	92	17	17.780	12.065	18.6		95
B13	1	- 3	99	5	23.825	12.065	24.1		250
B23	2	- 3	112	18	23.825	17.780	24.7		190
B14	1	- 4	124	6.5	31.267	12.065	31.6		550
B24	2	- 4	124	6.5	31.267	17.780	31.6		480
B34	3	- 4	140	22.5	31.267	23.825	32.4		360
B15	1	- 5	156	6.5	44.399	12.065	44.7		1700
B25	2	- 5	156	6.5	44.399	17.780	44.7		1520
B35	3	- 5	156	6.5	44.399	23.825	44.7		1360
B45	4	- 5	171	21.5	44.399	31.267	45.5		1020
B36	3	- 6	218	8	63.348	23.825	63.8		5300
B46	4	- 6	218	8	63.348	31.267	63.8		5010
B56	5	- 6	218	8	63.348	44.399	63.8		4200

Oil toughened reducing sleeves externally precision ground with hardened tang

Outside taper
Morse DIN 228

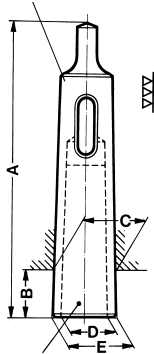

Inside taper
Morse DIN 228

Model No.	Morse taper		A mm	B mm	C mm	D mm	E mm	Packaging style	Weight g
	inside	outside							
B01OT	0	- 1	80	19	12.065	9.045	13.0	Individual box	30
B12OT	1	- 2	92	17	17.780	12.065	18.6		95
B13OT	1	- 3	99	5	23.825	12.065	24.1		250
B23OT	2	- 3	112	18	23.825	17.780	24.7		190
B14OT	1	- 4	124	6.5	31.267	12.065	31.6		550
B24OT	2	- 4	124	6.5	31.267	17.780	31.6		480
B34OT	3	- 4	140	22.5	31.267	23.825	32.4		360
B15OT	1	- 5	156	6.5	44.399	12.065	44.7		1700
B25OT	2	- 5	156	6.5	44.399	17.780	44.7		1520
B35OT	3	- 5	156	6.5	44.399	23.825	44.7		1360
B45OT	4	- 5	171	21.5	44.399	31.267	45.5		1020
B36OT	3	- 6	218	8	63.348	23.825	63.8		5300
B46OT	4	- 6	218	8	63.348	31.267	63.8		5010
B56OT	5	- 6	218	8	63.348	44.399	63.8		4200

Reducing sleeves with plain through hole, hardened and tempered, precision ground internally and externally

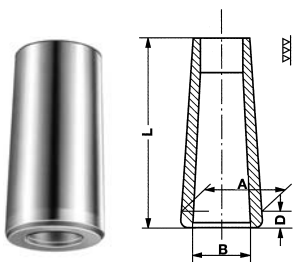

Model No.	Morse taper		L mm	D mm	A mm	B mm	Packaging style	Weight g
	inside	outside						
B12TH	1	- 2	50	4	17.780	12.065	Individual box	50
B13TH	1	- 3	55	4.5	23.825	12.065		140
B23TH	2	- 3	60	4.5	23.825	17.780		90
B14TH	1	- 4	65	5.3	31.267	12.065		320
B24TH	2	- 4	70	5.3	31.267	17.780		260
B34TH	3	- 4	75	5.3	31.267	23.825		170
B25TH	2	- 5	80	6.3	44.400	17.780		770
B35TH	3	- 5	90	6.3	44.400	23.825		740
B45TH	4	- 5	95	6.3	44.400	31.267		560
B36TH	3	- 6	110	7.9	63.380	23.825		2200
B46TH	4	- 6	120	7.9	63.380	31.267		2100
B56TH	5	- 6	125	7.9	63.380	44.400		1510

Morse taper turret sockets, hardened case, ground internally and externally

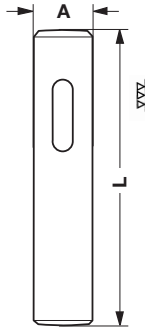

Inside taper Morse DIN 228

Model No.	Diameter A	Morse taper	L mm	Packaging style	Weight g
TS75MT1	3/4"	1	89	Individual box	280
TS1MT1	1"	1	89	Individual box	300
TS1MT2		2	102		
TS15MT1	1.1/2"	1	89	Individual box	600
TS15MT2		2	102		770
TS15MT3		3	121		820
TS15MT4		4	153		1150
TS2MT3	2"	3	121	Individual box	1500
TS2MT4		4	153		1800
TS2125MT3	2.1/8"	3	121	Individual box	1750
TS2125MT4		4	153		2100
TS2125MT5		5	228		2500
TS25MT3	2.1/2"	3	121	Individual box	2500
TS25MT4		4	153		2900
TS25MT5		5	228		4500
TSM20MT1	20 mm	1	89	Individual box	280
TSM25MT1	25 mm	1	89	Individual box	300
TSM25MT2		2	102		
TSM30MT3	30 mm	3	121	Individual box	750
TSM40MT2	40 mm	2	102	Individual box	770
TSM40MT3		3	121		820
TSM40MT4		4	153		1150
TSM50MT3	50 mm	3	121	Individual box	1750
TSM50MT4		4	153		2100

Iso taper to Morse taper adaptors according to DIN 2080 hardened and tempered, precision ground internally and externally

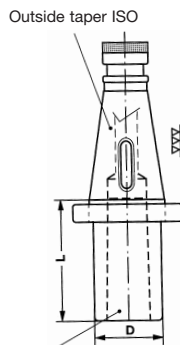

Inside taper Morse DIN 228

Model No.	Iso taper outside	Morse taper inside	D mm	L mm	Drawbolt thread	Packaging style	Weight g
ISO30MT2	30	2	34	50	M12	Individual box	400
ISO30MT3		3	40	70			600
ISO40MT2	40	2	34	50	M16	Individual box	900
ISO40MT3		3	40	65			1000
ISO40MT4		4	50	95			1300
ISO50MT3	50	3	40	65	M24	Individual box	2800
ISO50MT4		4	50	70			2800
ISO50MT5		5	65	105			3200

Extension sockets according to DIN 2187, hardened and tempered, precision ground internally and externally



Model No.	Morse taper outside	Morse taper inside	a ₁ mm	a ₂ mm	d ₁ mm	d ₂ mm	d ₃ mm	l ₁ mm	l ₂ mm	Packaging style	Weight g
BL11145	1	1	-	7	12.065	12.065	20	145	83	Individual box	190
BL12160		2				17.780	30	160	98		250
BL21160	2	1	-	9	17.780	12.065	20	160	85	Individual box	340
BL22175		2				17.780	30	175	100		400
BL23196		3				23.825	36	196	121		550
BL31175	3	1	5	-	23.825	12.065	20	175	81	Individual box	400
BL32194		2	-	9		17.780	30	194	100		840
BL33215		3	-	9		23.825	36	215	121		1000
BL34240		4	-	9		31.267	48	240	146		1300
BL41200	4	1	6.5	-	31.267	12.065	20	200	82.5	Individual box	800
BL42215		2	6.5	-		17.780	30	215	97.5		850
BL43240		3	-	10.5		23.825	36	240	122.5		1500
BL44265		4	-	10.5		31.267	48	265	147.5		1900
BL45300		5	-	10.5		44.399	63	300	182.5		2750
BL51232	5	1	6.5	-	44.399	12.065	20	232	82.5	Individual box	1600
BL52247		2	6.5	-		17.780	30	247	97.5		1600
BL53268		3	6.5	-		23.825	36	268	118.5		2840
BL54300		4	-	13.5		31.267	48	300	150.5		3310
BL55335		5	-	13.5		44.399	63	335	185.5		4200

Oil toughened extension sockets externally precision ground with hardened tang

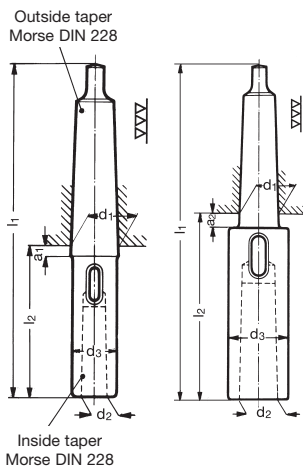

Model No.	Morse taper outside	Morse taper inside	a ₁ mm	a ₂ mm	d ₁ mm	d ₂ mm	d ₃ mm	l ₁ mm	l ₂ mm	Packaging style	Weight g
BL11145OT	1	1	-	7	12.065	12.065	20	145	83	Individual box	190
BL12160OT		2				17.780	30	160	98		250
BL21160OT	2	1	-	9	17.780	12.065	20	160	85	Individual box	340
BL22175OT		2				17.780	30	175	100		400
BL23196OT		3				23.825	36	196	121		550
BL31175OT	3	1	5	-	23.825	12.065	20	175	81	Individual box	400
BL32194OT		2	-	9		17.780	30	194	100		840
BL33215OT		3	-	9		23.825	36	215	121		1000
BL34240OT		4	-	9		31.267	48	240	146		1300
BL41200OT	4	1	6.5	-	31.267	12.065	20	200	82.5	Individual box	800
BL42215OT		2	6.5	-		17.780	30	215	97.5		850
BL43240OT		3	-	10.5		23.825	36	240	122.5		1500
BL44265OT		4	-	10.5		31.267	48	265	147.5		1900
BL45300OT		5	-	10.5		44.399	63	300	182.5		2750
BL51232OT	5	1	6.5	-	44.399	12.065	20	232	82.5	Individual box	1600
BL52247OT		2	6.5	-		17.780	30	247	97.5		1600
BL53268OT		3	6.5	-		23.825	36	268	118.5		2840
BL54300OT		4	-	13.5		31.267	48	300	150.5		3310
BL55335OT		5	-	13.5		44.399	63	335	185.5		4200

Oil toughened long pattern extension sockets externally precision ground with hardened tang

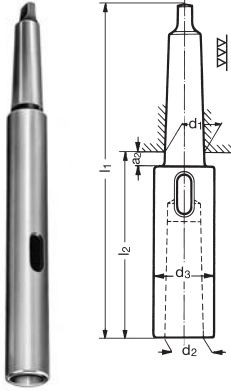

Model No.	Morse taper outside	Morse taper inside	a ₁ mm	a ₂ mm	d ₁ mm	d ₂ mm	d ₃ mm	l ₁ mm	l ₂ mm	Packaging style	Weight g	
BL11200OT	1	-	1	-	7	12.065	12.065	20	200	138	Individual box	250
BL11250OT									250	188		375
BL11300OT									300	238		500
BL11350OT									350	288		625
BL11400OT									400	338		750
BL11450OT									450	388		875
BL11500OT									500	438		1000
BL22200OT	2	-	2	-	9	17.780	17.780	25	200	125	Individual box	430
BL22250OT									250	175		625
BL22300OT									300	225		820
BL22350OT									350	275		1015
BL22400OT									400	325		1200
BL22450OT									450	375		1400
BL22500OT									500	425		1600
BL22600OT	600	525	1800									
BL33250OT	3	-	3	-	9	23.825	23.825	32	250	156	Individual box	1000
BL33300OT									300	206		1300
BL33350OT									350	256		1550
BL33400OT									400	306		1850
BL33450OT									450	356		2100
BL33500OT									500	406		2400
BL33600OT	600	506	2700									
BL44300OT	4	-	4	-	10.5	31.267	31.267	40	300	182.5	Individual box	1650
BL44350OT									350	232.5		2150
BL44400OT									400	282.5		2650
BL44450OT									450	332.5		3100
BL44500OT									500	382.5		3600
BL44600OT									600	482.5		4200