

TAURUS range keyless chucks

Designed to exceed the performance of conventional drill chucks, the TAURUS range, represents a revolutionary new concept in technology and are precision engineered to enable the operator to lock the bit firmly in the chuck by hand.

- Suitable for Forward, Reverse and Percussion
- Nylon and Full metal version
- Double and single sleeve suitable for conventional and spindle lock machines
- Antilock mechanism
- Standard and Carbide jaw bite
- High performance for machines up to **1100 Watts** impact applications

Model numbers ending in letter R indicate chuck supplied with through hole to accommodate a left hand locking screw for reversing tools.

A TORX® wrench can also be used to lock the keyless chucks to the drilling machine spindle. No left hand screw is needed in this case.

TAURUS REGULAR

Hard nylon two piece sleeve, metal nose cap, suitable for machines in forward and reverse mode. Hand tightening style.

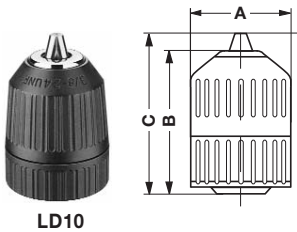

Model No.	Drilling capacity mm	Mount	A mm	B mm	C mm	Max machine rating	Packaging style	Weight g
LD10F12R	1.5-10	1/2" x 20	42.7	55	62	Suitable for machines in forward and reverse mode only	Individual box	182
LD10F12RB							Blister card	
LD10F38R		3/8" x 24					Individual box	
LD10F38RB							Blister card	

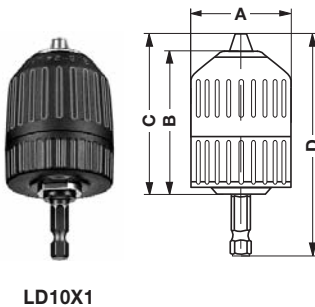

KEYLESS CHUCKS FOR SCREWDRIVERS

with 1/4" male hexagonal mount to DIN 3126 - E 6.3.

Model No.	Drilling capacity mm	A mm	B mm	C mm	D mm	Packaging style	Weight g
LD10X1B	1.5-10	42.7	55	62	80	Individual box	200

TAURUS PROFESSIONAL

Hard nylon two piece sleeve, metal nose cap, suitable for machines in forward, reverse and percussion mode. Hand tightening style.

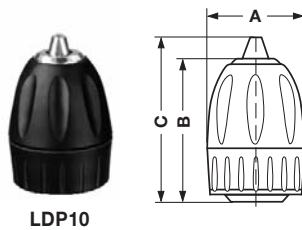

Model No.	Drilling capacity mm	Mount	A mm	B mm	C mm	Max machine rating	Packaging style	Weight g
LDP10F12R	1.5-10	1/2" x 20	42.7	55	63	450 W	Individual box	172
LDP10F12RB							Blister card	
LDP10F38R		3/8" x 24					Individual box	
LDP10F38RB							Blister card	

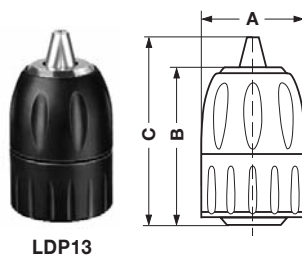

LDP13F12R	2-13	1/2" x 20	42.7	62	76	710 W	Individual box	290
LDP13F12RB							Blister card	
LDP13F38R		3/8" x 24					Individual box	
LDP13F38RB							Blister card	
LDP13SDS		SDS					Individual box	
LDP13SDSB							Blister card	



LDP10SQ

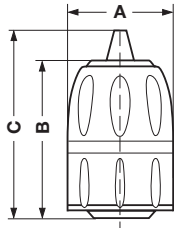

TAURUS PROFESSIONAL - SPINDLE LOCK SYSTEM

For machines with Spindle Lock system. Hard nylon single sleeve suitable for forward, reverse and percussion mode.

Model No.	Drilling capacity mm	Mount	A mm	B mm	C mm	Max machine rating	Packaging style	Weight g
LDP13F12R	2-13	1/2" x 20	42.7	62	73	710 W	Individual box	280
LDP13F12RB							Blister card	



LDP10SQ

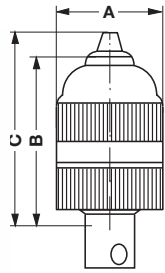

new

TAURUS PROFESSIONAL - FOR IMPACT DRIVERS

Model No.	Drilling capacity mm	Mount	A mm	B mm	C mm	Max torque	Packaging style	Weight g
LDP10SQ38	1-10	Quadro 3/8"	41	77	85	100 Nm	Individual box	232
LDP10SQ12		Quadro 1/2"	41	80	88			263

TAURUS SUPER suitable for forward, reverse and impact mode. standard jaws with serrated bite.

Hard nylon two piece sleeve



TSP10

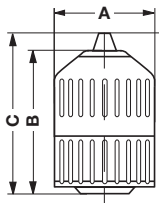

Model No.	Drilling capacity mm	Mount	A mm	B mm	C mm	Max machine rating	Packaging style	Weight g
TSP10F12R	1.5-10	1/2" x 20	42.7	55	64	1100 W	Individual box	165
TSP10F12RB							Blister card	
TSP10F38R		3/8" x 24					Individual box	
TSP10F38RB							Blister card	

Hard nylon front sleeve and rear metal sleeve



TSMP10

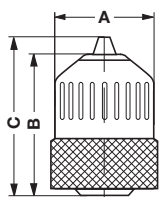

Model No.	Drilling capacity mm	Mount	A mm	B mm	C mm	Max machine rating	Packaging style	Weight g
TSMP10F12R	1.5-10	1/2" x 20	42.7	55	64	1100 W	Individual box	195
TSMP10F12RB							Blister card	
TSMP10F38R		3/8" x 24					Individual box	
TSMP10F38RB							Blister card	



TSP13

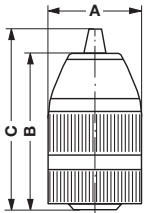

Hard nylon two piece sleeve

Model No.	Drilling capacity mm	Mount	A mm	B mm	C mm	Max machine rating	Packaging style	Weight g
TSP13F12R	1.5-13	1/2" x 20	42.7	64	75.3	1100 W	Individual box	260
TSP13F12RB							Blister card	



TS13

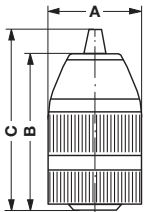

Full metal two piece sleeve

Model No.	Drilling capacity mm	Mount	A mm	B mm	C mm	Max machine rating	Packaging style	Weight g
TS13F12R	1.5-13	1/2" x 20	42.7	64	75.3	1100 W	Individual box	295
TS13F12RB							Blister card	
TS13F38R		3/8" x 24					Individual box	
TS13F38RB							Blister card	
TS13SDS		SDS					Individual box	
TS13SDSB							Blister card	

TAURUS SUPER - SPINDLE LOCK SYSTEM

For machines with Spindle Lock system, suitable for forward, reverse and impact mode. Standard jaws with serrated bite.



TSSP10

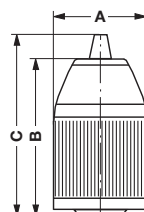

Hard nylon single sleeve

Model No.	Drilling capacity mm	Mount	A mm	B mm	C mm	Max machine rating	Packaging style	Weight g
TSSP10F12R	1.5-10	1/2" x 20	42.7	57.5	64	1100 W	Individual box	161
TSSP10F12RB							Blister card	
TSSP10F38R		3/8" x 24					Individual box	
TSSP10F38RB							Blister card	



TSS13

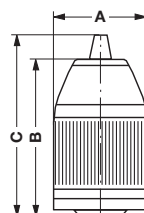

Full metal single sleeve

Model No.	Drilling capacity mm	Mount	A mm	B mm	C mm	Max machine rating	Packaging style	Weight g
TSS13F12R	1.5-13	1/2" x 20	42.7	64	75.3	1100 W	Individual box	295
TSS13F12RB							Blister card	



TAURUS ULTIMATE

Suitable for forward, reverse and impact mode.
Carbide jaw bite to ensure better gripping.

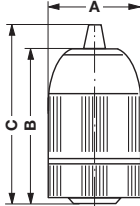

TUP13

Hard nylon two piece sleeve

Model No.	Drilling capacity mm	Mount	A mm	B mm	C mm	Max machine rating	Packaging style	Weight g
TUP13F12R TUP13F12RB	1.5-13	1/2" x 20	42.7	63.5	75.3	1100 W	Individual box Blister card	248

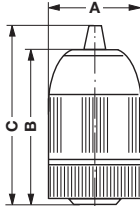

TUMP13

Hard nylon front sleeve and rear metal sleeve

Model No.	Drilling capacity mm	Mount	A mm	B mm	C mm	Max machine rating	Packaging style	Weight g
TUMP13F12R TUMP13F12RB	1.5-13	1/2" x 20	42.7	63.5	75.3	1100 W	Individual box Blister card	282

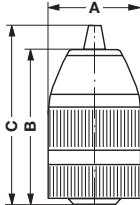

TU13

Full metal two piece sleeve

Model No.	Drilling capacity mm	Mount	A mm	B mm	C mm	Max machine rating	Packaging style	Weight g
TUMP13F12R TUMP13F12RB	1.5-13	1/2" x 20	42.7	63.5	75.3	1100 W	Individual box Blister card	282

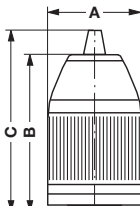

TUS13

TAURUS ULTIMATE - SPINDLE LOCK SYSTEM

For machines with Spindle Lock system, suitable for forward, reverse and impact mode. Carbide jaws.

Model No.	Drilling capacity mm	Mount	A mm	B mm	C mm	Max machine rating	Packaging style	Weight g
TUS13F12R TUS13F12RB	1.5-13	1/2" x 20	42.7	64	75.3	1100 W	Individual box Blister card	295